



UPC816

PHOTOCOUPLER

4 PIN DIP PHOTOTRANSISTOR PHOTOCOUPLER

DESCRIPTION

The UTC **UPC816** is a 4 pin DIP phototransistor photocoupler, it uses UTC's advanced technology to provide the customers with high isolation voltage between input and output, etc.

The UTC **UPC816** is suitable for programmable controllers and telecommunication equipments, etc.

FEATURES

- * High isolation voltage between input and output
- * Creepage distance > 7.62 mm

SYMBOL

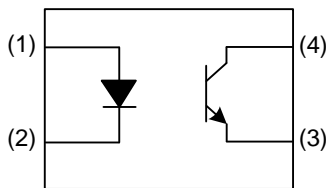

ORDERING INFORMATION

Ordering Number		Package	Pin Assignment				Packing
Lead Free	Halogen Free		1	2	3	4	
UPC816L-C04-R	UPC816G-C04-R	SMD-4	A	K	E	C	Tape Reel
UPC816xL-C04-R	UPC816xG-C04-R	SMD-4	A	K	E	C	Tape Reel
UPC816L-C04C-R	UPC816G-C04C-R	SMD-4C	A	K	E	C	Tape Reel
UPC816xL-C04C-R	UPC816xG-C04C-R	SMD-4C	A	K	E	C	Tape Reel
UPC816L-D04-T	UPC816G-D04-T	DIP-4	A	K	E	C	Tube
UPC816xL-D04-T	UPC816xG-D04-T	DIP-4	A	K	E	C	Tube
UPC816L-D04C-T	UPC816G-D04C-T	DIP-4C	A	K	E	C	Tube
UPC816xL-D04C-T	UPC816xG-D04C-T	DIP-4C	A	K	E	C	Tube
UPC816L-D04M-T	UPC816G-D04M-T	DIP-4M	A	K	E	C	Tube
UPC816xL-D04M-T	UPC816xG-D04M-T	DIP-4M	A	K	E	C	Tube
UPC816L-LS04-R	UPC816G-LS04-R	LSOP-4	A	K	E	C	Tape Reel
UPC816xL-LS04-R	UPC816xG-LS04-R	LSOP-4	A	K	E	C	Tape Reel

Note: Pin Assignment: A: Anode K: Cathode E: Emitter C: Collector

<p>UPC816xG-C04-R</p>	<p>(1) R: Tape Reel, T: Tube (2) C04: SMD-4, C04C: SMD-4C, D04: DIP-4 D04C: DIP-4C, D04M: DIP-4M, LS04: LSOP-4 (3) G: Halogen Free and Lead Free, L: Lead Free (4) Refer to TRANSFER CHARACTERISTICS</p>
-----------------------	--

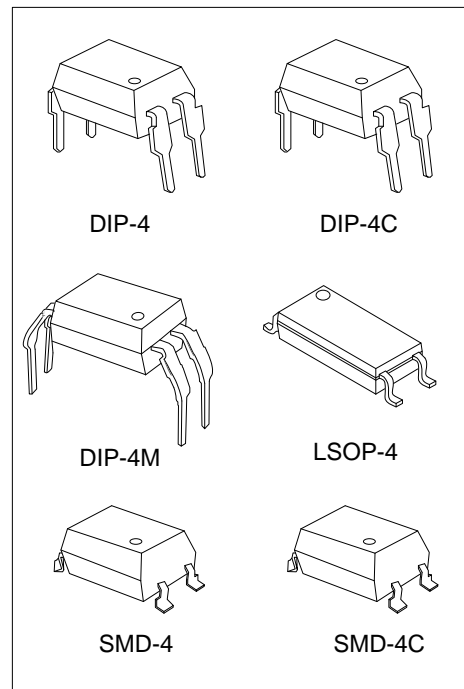

■ MARKING

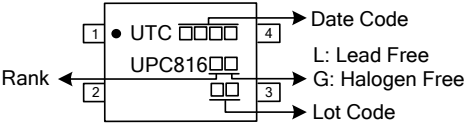

■ ABSOLUTE MAXIMUM RATING (T_A=25°C, unless otherwise specified)

PARAMETER		SYMBOL	RATINGS	UNIT
Input	Forward Current	I _F	60	mA
	Peak Forward Current (1μs, Pulse)	I _{FP}	1	A
	Reverse Voltage	V _R	6	V
	Power Dissipation	P _D	100	mW
	Derating Factor		1	mW/°C
Output	Power Dissipation	P _C	150	mW
	Derating Factor		1.5	mW/°C
	Collector Current	I _C	50	mA
	Collector-Emitter Voltage	V _{CEO}	80	V
	Emitter-Collector Voltage	V _{ECO}	6	V
Total Power Dissipation		P _{TOT}	200	mW
Isolation Voltage (Note 2)		V _{ISO}	5000	V _{rms}
Operating Temperature		T _{OPR}	-55 ~ +110	°C
Storage Temperature		T _{STG}	-55 ~ +125	°C

Notes: 1. Absolute maximum ratings are those values beyond which the device could be permanently damaged. Absolute maximum ratings are stress ratings only and functional device operation is not implied.

2. AC for 1 minute, R.H.= 40~60% R.H. In this test, pins 1, 2 are shorted together, and pins 3, 4 are shorted together.

■ ELECTRICAL CHARACTERISTICS (T_A=25°C, unless otherwise specified)

PARAMETER	SYMBOL	TEST CONDITIONS	MIN	TYP	MAX	UNIT
INPUT						
Forward Voltage	V _F	I _F =20mA		1.2	1.4	V
Reverse Current	I _R	V _R =4V			10	μA
Input Capacitance	C _{IN}	V=0, f=1kHz		30	250	pF
OUTPUT						
Collector-Emitter Dark Current	I _{CEO}	V _{CE} =20V, I _F =0mA			100	nA
Collector-Emitter Breakdown Voltage	BV _{CEO}	I _C =0.1mA	80			V
Emitter-Collector Breakdown Voltage	BV _{ECO}	I _E =0.1mA	6			V

■ TRANSFER CHARACTERISTICS (T_A=25°C, unless otherwise specified)

PARAMETER	SYMBOL	TEST CONDITIONS	MIN	TYP	MAX	UNIT	
Current Transfer Ratio	CTR	I _F =5mA, V _{CE} =5V	UPC816	50		600	%
			UPC816A	80		160	%
			UPC816B	130		260	%
			UPC816C	200		400	%
			UPC816D	300		600	%
			UPC816X	100		200	%
			UPC816Y	150		300	%
Collector-Emitter Saturation Voltage	V _{CE(sat)}	I _F =20mA, I _C =1mA		0.1	0.2	V	
Isolation Resistance	R _{IO}	V _{IO} =500Vdc, 40~60% R.H.	5×10 ¹⁰			Ω	
Floating Capacitance	C _{IO}	V _{IO} =0, f=1MHz		0.6	1.0	pF	
Cut-Off Frequency	f _C	V _{CE} =5V, I _C =2mA, R _L =100Ω, -3dB		80		kHz	
Rise Time	t _R	V _{CE} =2V, I _C =2mA, R _L =100Ω		4	18	μs	
Fall Time	t _F			3	18	μs	

■ TEST CIRCUITS AND WAVEFORMS

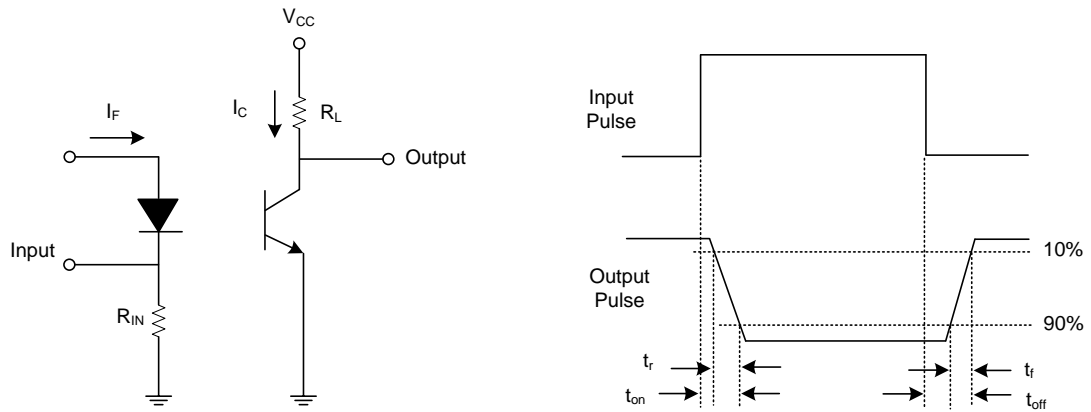

Switching Time Test Circuit & Waveforms

■ TYPICAL CHARACTERISTICS

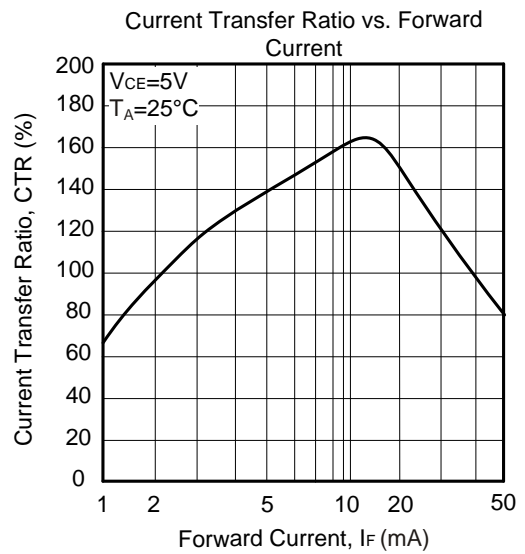
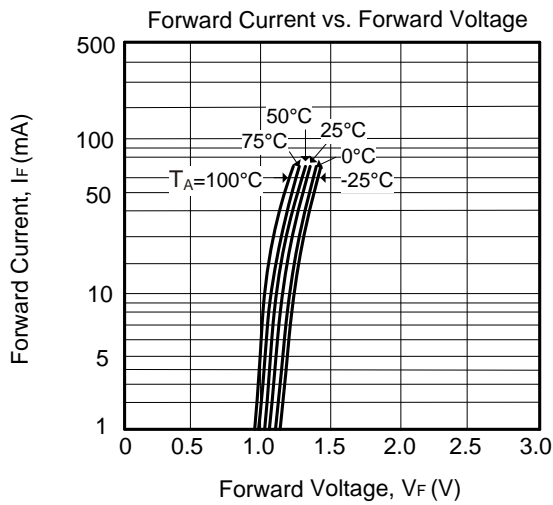
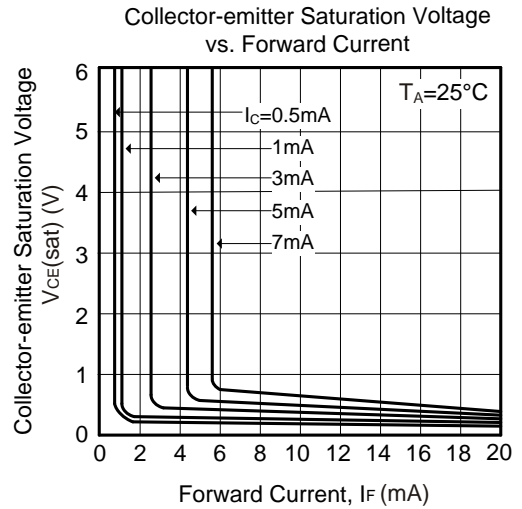
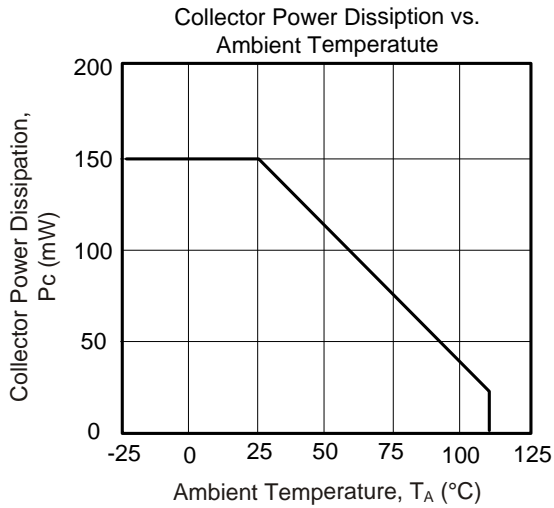
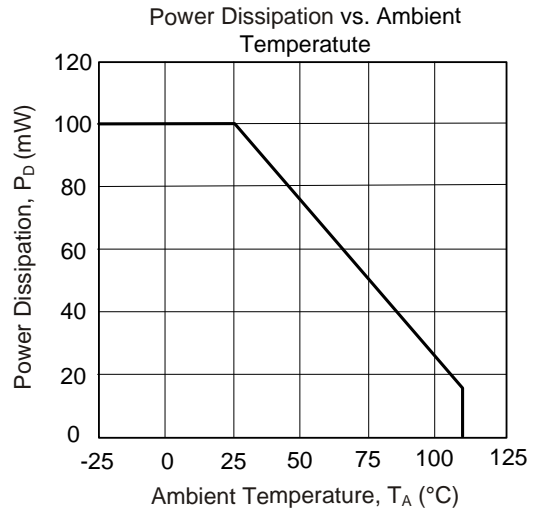
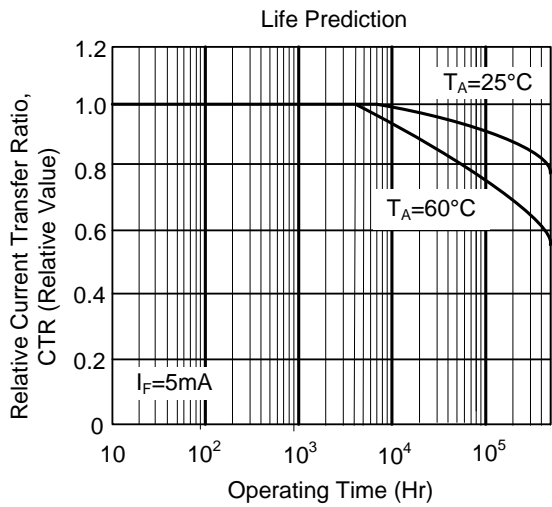

■ TYPICAL CHARACTERISTICS

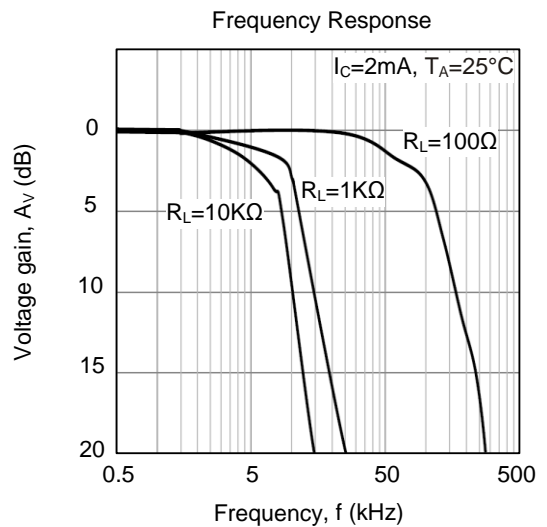
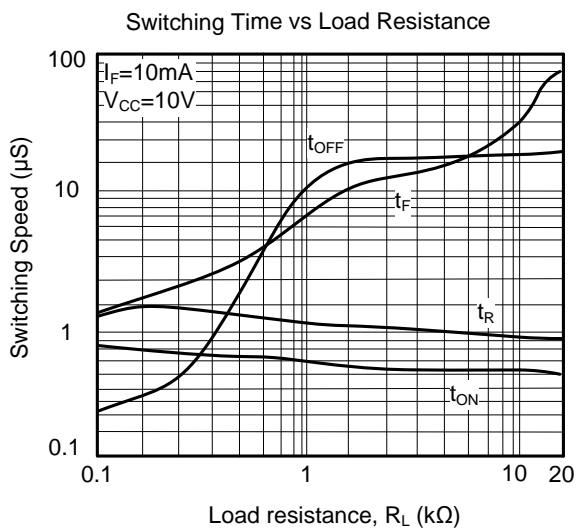
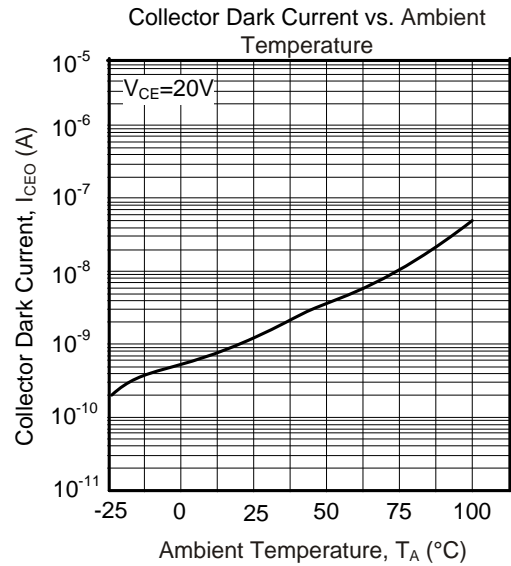
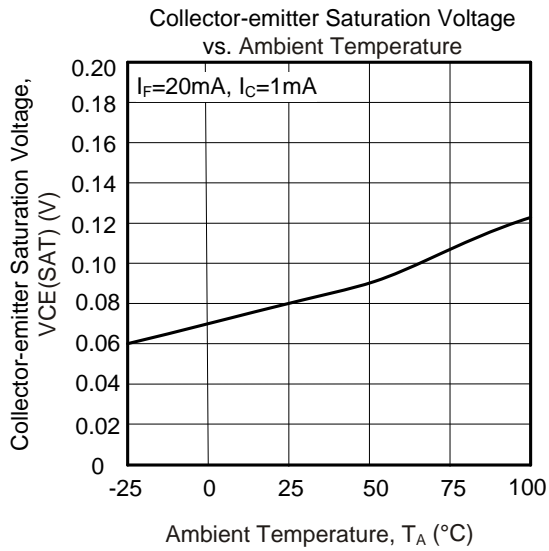
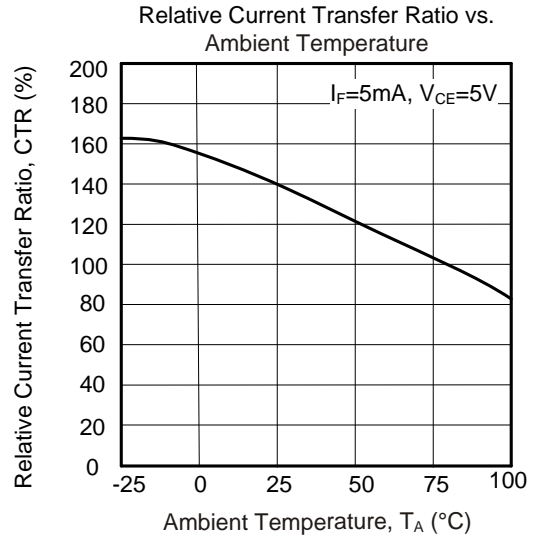
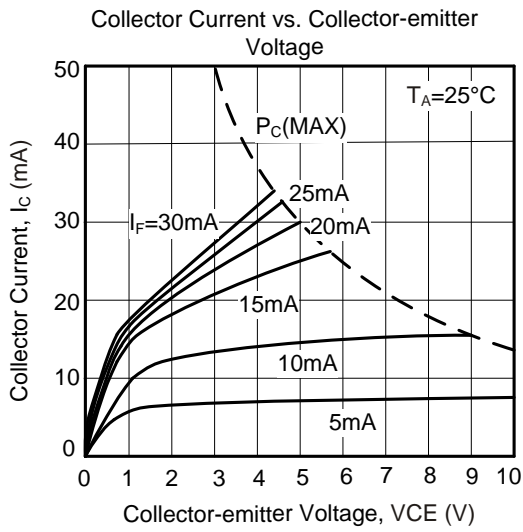

UTC assumes no responsibility for equipment failures that result from using products at values that exceed, even momentarily, rated values (such as maximum ratings, operating condition ranges, or other parameters) listed in products specifications of any and all UTC products described or contained herein. UTC products are not designed for use in life support appliances, devices or systems where malfunction of these products can be reasonably expected to result in personal injury. Reproduction in whole or in part is prohibited without the prior written consent of the copyright owner. UTC reserves the right to make changes to information published in this document, including without limitation specifications and product descriptions, at any time and without notice. This document supersedes and replaces all information supplied prior to the publication hereof.